

香港考試局**HONG KONG EXAMINATIONS AUTHORITY****一九九九年香港中學會考****HONG KONG CERTIFICATE OF EDUCATION EXAMINATION, 1999****數學 試卷一****MATHEMATICS PAPER 1**

本評卷參考乃考試局專為今年本科考試而編寫，供閱卷員參考之用。閱卷員在完成閱卷工作後，若將本評卷參考提供其任教會考班的本科同事參閱，本局不表反對，但須切記，在任何情況下均不得容許本評卷參考落入學生手中。學生若索閱或求取此等文件，閱卷員/教師應嚴詞拒絕，因學生極可能將評卷參考視為標準答案，以致但知硬背死記，活剝生吞。這種落伍的學習態度，既不符現代教育原則，亦有違考試着重理解能力與運用技巧之旨。因此，本局籲請各閱卷員/教師通力合作，堅守上述原則。

This marking scheme has been prepared by the Hong Kong Examinations Authority for markers' reference. The Examinations Authority has no objection to markers sharing it, after the completion of marking, with colleagues who are teaching the subject. However, under no circumstances should it be given to students because they are likely to regard it as a set of model answers. Markers/teachers should therefore firmly resist students' requests for access to this document. Our examinations emphasise the testing of understanding, the practical application of knowledge and the use of processing skills. Hence the use of model answers, or anything else which encourages rote memorisation, should be considered outmoded and pedagogically unsound. The Examinations Authority is counting on the co-operation of markers/teachers in this regard.

考試結束後，各科評卷參考將存放於教師中心，供教師參閱。

After the examinations, marking schemes will be available for reference at the Teachers' Centres.



Hong Kong Certificate of Education Examination
Mathematics Paper I

General Marking Instructions

1. It is very important that all markers should adhere as closely as possible to the marking scheme. In many cases, however, candidates will have obtained a correct answer by an alternative method not specified in the marking scheme. In general, a correct answer merits *all the marks* allocated to that part, unless a particular method has been specified in the question. Markers should be patient in marking alternative solutions not specified in the marking scheme.
2. In the marking scheme, marks are classified into the following three categories:

'M' marks	awarded for correct methods being used;
'A' marks	awarded for the accuracy of the answers;
Marks without 'M' or 'A'	awarded for correctly completing a proof or arriving at an answer given in a question.

In a question consisting of several parts each depending on the previous parts, 'M' marks should be awarded to steps or methods correctly deduced from previous answers, even if these answers are erroneous. However, 'A' marks for the corresponding answers should NOT be awarded (unless otherwise specified).
3. For the convenience of markers, the marking scheme was written as detailed as possible. However, it is still likely that candidates would not present their solution in the same explicit manner, e.g. some steps would either be omitted or stated implicitly. In such cases, markers should exercise their discretion in marking candidates' work. In general, marks for a certain step should be awarded if candidates' solution indicated that the relevant concept/technique had been used.
4. Use of notation different from those in the marking scheme should not be penalized.
5. In marking candidates' work, the benefit of doubt should be given in the candidates' favour.
6. Marks may be deducted for poor presentation (*pp*). The symbol $\textcircled{pp-1}$ should be used to denote 1 mark deducted for *pp*.
 - a. At most deduct 1 mark for *pp* in each question, up to a maximum of 3 marks for the whole paper.
 - b. For similar *pp*, deduct 1 mark for the first time that it occurs. Do not penalize candidates twice in the paper for the same *pp*.
7. Marks may be deducted for no/wrong units (*u*). The symbol $\textcircled{u-1}$ should be used to denote 1 mark deducted for *u*. At most deduct 1 mark for *u* for the whole paper.
8. In any case, do not deduct any marks for *pp* or *u* in those steps where candidates could not score any marks.
9. Marks entered in the Page Total Box should be the NET total scored on that page.
10. In the marking scheme, 'r.t.' stands for 'accepting answers which can be rounded off to' and 'f.t.' stands for 'follow through'. Steps which can be skipped are shaded whereas alternative answers are enclosed by rectangles.

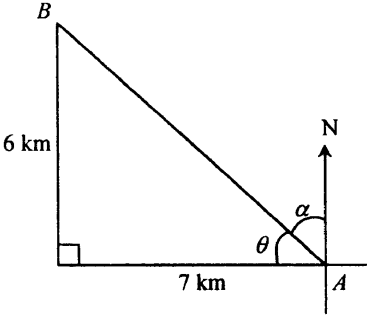
Solution	Marks	Remarks
1. $\frac{(a^{-3})^2}{a} = \frac{a^{-3 \times 2}}{a}$ (or $\frac{a^{-6}}{a}$) $= \frac{1}{a^6 a}$ (or $a^{-6} a^{-1}, a^{-7}$) $= \frac{1}{a^7}$	1M 1M 1A (3)	applying $(a^m)^n = a^{mn}$ applying $a^{-m} = \frac{1}{a^m}$
2. $a = b + \frac{c}{x}$ $a - b = \frac{c}{x}$ $(a - b)x = c$ $x = \frac{c}{a - b}$	1A 2A	putting x on one side
$a = \frac{bx + c}{x}$ $ax - bx = c$ $(a - b)x = c$ $x = \frac{c}{a - b}$	1A 2A	putting x on one side
3. (i) $3x - 4 > 2(x - 1)$ $3x - 4 > 2x - 2$ $x > 2$ (ii) $x < 6$ For (i) and (ii): $2 < x < 6$	(3) 1A 1A 1A (3)	accept graphical solution
4. Refer to the figure,  $\tan \alpha = \frac{7}{6}$ $\alpha \approx 49.4^\circ$ (or $49^\circ 24'$)	1M 1A	accept undefined symbols r.t. 49 (49.3987)
$\tan \theta = \frac{6}{7}$ $\theta \approx 40.6^\circ$ (or $40^\circ 36'$)	1M 1A	r.t. 41 (40.6013)
The bearing of B from A is $N49.4^\circ W$ (or $N49^\circ 24' W, 311^\circ$)	1A (3)	r.t. 49.4 or 311

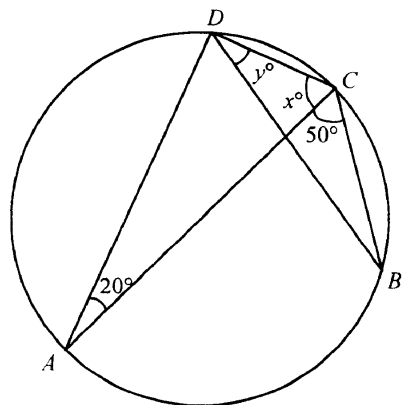
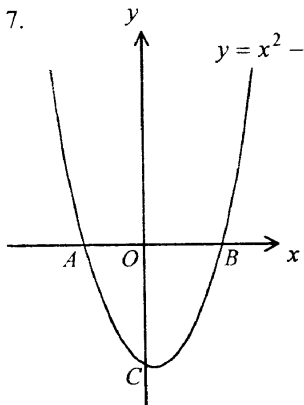
Solution	Marks	Remarks
<p>5.</p>  <p> $\therefore \angle ADC = 90^\circ$ $\therefore x = 180 - 90 - 20 = 70$ $\therefore \angle ADB = 50^\circ$ (or $\angle CBD = 20^\circ$) $\therefore y = 90 - 50 = 40$ (or $y = 180 - 20 - 50 - 70 = 40$) </p>	<p>1M 1A 1M <u>1A</u> (4)</p>	<p>can be absorbed by exp. below using \angles in same segment can be absorbed by exp. below <i>pp</i>-1 for $x^\circ = 70^\circ$ etc. <i>u</i>-1 for $x = 70^\circ$ etc.</p>
<p>6. $y = ax + bx^2$ for some non-zero constants a and b.</p> $\begin{cases} 20 = 2a + 4b & \dots(1) \\ 39 = 3a + 9b & \dots(2) \end{cases}$ <p>(2)\times2 - (1)\times3: (1)\times9 - (2)\times4:</p> $\begin{cases} 18 = 6b \\ 24 = 6a \end{cases}$ <p>$\therefore \begin{cases} a = 4 \\ b = 3 \end{cases}$</p> <p>$y = 4x + 3x^2$</p>	<p>1A 1M 1M 1A <u>(4)</u></p>	<p>for either eliminating a or b</p>
<p>7.</p>  <p> $\therefore y = x^2 - x - 6 = (x+2)(x-3)$ $\therefore \begin{cases} a = -2 \\ b = 3 \end{cases}$ </p>	<p>1A 1M+1A</p>	<p>for factorization award 1M only when $a < b$</p>
<p>$c = -6$</p>	<p><u>1A</u> (4)</p>	<p>award 1M only when $a < b$ <i>pp</i>-1 for giving ans. in coordinate form</p>

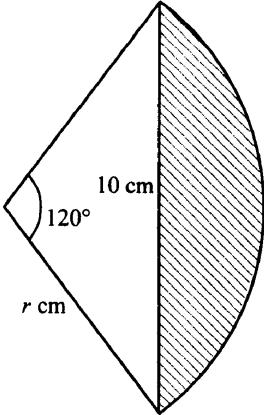
Solution	Marks	Remarks
8. (a) $\frac{x+161+168+159+161+152}{6} = 158$ $x = 147$	1A 1A	
(b) median = $\frac{159+161}{2}$ cm = 160 cm	1M 1A	
9. 		
(a) $\sin 60^\circ = \frac{5}{r}$ or $\frac{10^2 = r^2 + r^2 - 2r^2 \cos 120^\circ}{r} = \frac{10}{\sin 120^\circ}$	1A	
$r \approx 5.77$ (or $\frac{10\sqrt{3}}{3}, \frac{10}{\sqrt{3}}$)	1A	r.t. 5.77 (5.7735)
(b) Area of sector = $\frac{120}{360} r^2 \pi$ (cm ²)	1M	
Area of $\Delta = \frac{1}{2} r^2 \sin 120^\circ$ (cm ²)	1M	
Area of the shaded region = $\left[\frac{120}{360} r^2 \pi - \frac{1}{2} r^2 \sin 120^\circ \right]$ (cm ²) $\approx 20.5 \text{ cm}^2$ (or $\left(\frac{100}{9} \pi - \frac{25\sqrt{3}}{3} \right) \text{ cm}^2$)	1A	r.t. 20.5 (20.473)
	(5)	

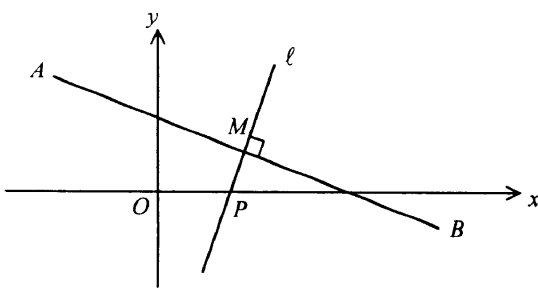
Solution	Marks	Remarks
<p>10.</p>  <p>(a) $M = \left(\frac{-8+16}{2}, \frac{8-4}{2}\right)$ $= (4, 2)$ Slope of $AB = \frac{-4-8}{16-(-8)}$ $= -\frac{1}{2}$ Slope of $l = 2$ Equation of l: $\frac{y-2}{x-4} = 2$ $2x - y - 6 = 0$</p>	<p>1A 1A 1M 1A</p>	<p>or equivalent</p>
$(x+8)^2 + (y-8)^2 = (x-16)^2 + (y+4)^2$ $x^2 + 16x + 64 + y^2 - 16y + 64 = x^2 - 32x + 256 + y^2 + 8y + 16$ $48x - 24y - 144 = 0$ $2x - y - 6 = 0$	<p>$\boxed{2A}$ $\boxed{1A}$ $\boxed{1A}$</p>	<p>or equivalent</p>
<p>(b) Sub. $y = 0$ into the equation of l, we have $x = 3$ i.e. $P = (3, 0)$ $BP = \sqrt{(16-3)^2 + (-4)^2}$ $= \sqrt{185}$ (or 13.6)</p> <p>(c) By mid-point theorem, $MN = \frac{1}{2}BP$ $= \frac{\sqrt{185}}{2}$ (or $\sqrt{\frac{185}{4}}$, 6.80)</p>	<p>(4) 1M 1A (2) 1A</p>	<p>r.t. 13.6 (13.601)</p> <p>r.t. 6.80 (6.8007)</p>
$N = \left(-\frac{5}{2}, 4\right)$ $MN = \sqrt{\left(4 + \frac{5}{2}\right)^2 + (2-4)^2}$ $= \frac{\sqrt{185}}{2}$ (or $\sqrt{\frac{185}{4}}$, 6.80)	<p>$\left. \begin{array}{l} \boxed{1M} \\ \boxed{1A} \end{array} \right\}$</p>	<p>r.t. 6.80 (6.8007)</p>
	<p>(2)</p>	

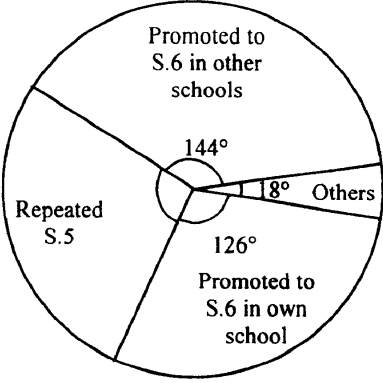
Solution	Marks	Remarks
<p>11. Placement of the 120 boys</p>  <p>(a) Number of boys who repeated S.5 = $120 \times \frac{360 - 144 - 18 - 126}{360}$ = 24</p> <p>(b) Percentage required = $\frac{126}{144 + 126} \times 100 (\%)$ $\approx 46.7 (\%)$</p>	<p>1A</p> <hr/> <p>1A</p> <p>(2)</p> <p>1A</p> <p>1A</p>	<p>r.t. 46.7 (46.6667)</p>
<p>Number of boys who promoted to S.6 in own school = $120 \times \frac{126}{360} = 42$</p> <p>Number of boys who promoted to S.6 in other school = $120 \times \frac{144}{360} = 48$</p> <p>Percentage required = $\frac{42}{42 + 48} \times 100 (\%)$ $\approx 46.7 (\%)$</p>	<p>1M</p> <p>1A</p>	
<p>(c) Number of students promoted to S.6 in own school = $120 \times \frac{126}{360} + 80 \times 22.5\%$ = 60</p> <p>Percentage required = $\frac{60}{200} \times 100 (\%)$ = 30 (%)</p>	<p>(2)</p> <p>1A</p> <hr/> <p>1A</p> <p>(2)</p>	

Solution	Marks	Remarks
12. (a) The probability that the next bus has an Octopus machine installed $= 0.75 \times 0.2$ (or $75\% \times 20\%$) $= 0.15$ (or 15% , $\frac{3}{20}$)	1A <hr/> 1A (2)	
(b) The probability that the total value of the coins taken out is exactly \$3.00 $= \frac{3}{5} \times \frac{2}{4} + \frac{2}{5} \times \frac{3}{4}$ $= \frac{3}{5}$ (or 0.6)	M+1M+1A 1A	1M for product rule ($p_1 \times p_2$) 1M for addition rule
Denote the two 1-dollar coins as A, B and the three 2-dollar coins as X, Y and Z, then sample space = {AB, AX, AY, AZ, BX, BY, BZ, XY, XZ, YZ} favourable event = {AX, AY, AZ, BX, BY, BZ} \therefore The probability required = $\frac{6}{10} = \frac{3}{5}$	1M+1A 1M 1A	1M for using appropriate notations for any one being correct
	<hr/> (4)	

13.

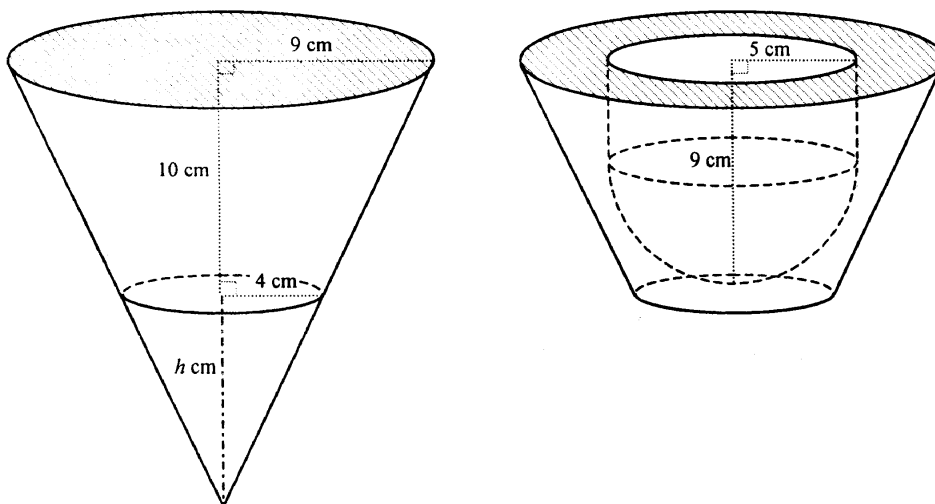

(a) Volume of the cylindrical part = $5^2(4)\pi$ (cm ³) Volume of the hemispherical part = $\frac{1}{2} \times \frac{4}{3} \times 5^3 \times \pi$ (cm ³) Capacity of the hole = $183\frac{1}{3}\pi$ cm ³ (or $\frac{550}{3}\pi$ cm ³)	1M 1A <hr/> 1A (3)	for $5^2 h\pi$ no mark for 183.3π etc.
(b) Let h cm be the height of the smaller cone cut off from the larger cone. $\frac{h}{4} = \frac{h+10}{9}$ $\frac{h}{4} = \frac{10}{5}$ $9h = 40 + 4h$ $h = 8$ Volume of wood in the pen-stand $= \frac{1}{3}(9^2)(10+8)\pi - \frac{1}{3}(4^2)(8)\pi - 183\frac{1}{3}\pi$ (cm ³) $= 260\pi$ cm ³	1A 1A 1M <hr/> 1A (4)	

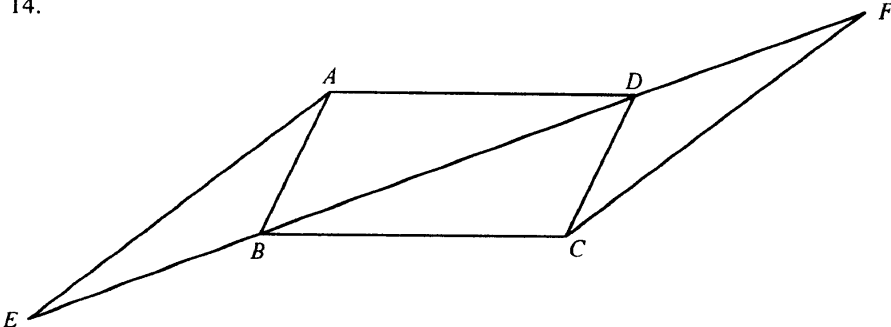
Solution	Marks	Remarks												
<p>14.</p>  <p>(a) (Line 1)... $\therefore \angle ABD = \angle CDB$ (alt. \angles, $AB \parallel DC$)</p> <p>(Line 2)... $\angle ABE = 180^\circ - \angle ABD$ and</p> <p>(Line 3)... $\angle CDF = 180^\circ - \angle CDB$ (adj. \angles on st. line)</p> <p>(Line 4)... $\therefore \angle ABE = \angle CDF$</p>		<p>accept (alt. \angles, // lines) [(內)錯角, $AB \parallel DC$] [直線上的鄰角]</p>												
<table border="1"> <thead> <tr> <th colspan="3">Marking Scheme :</th> </tr> </thead> <tbody> <tr> <td>Case 1</td> <td>Any correct proof with correct reasons.</td> <td>2</td> </tr> <tr> <td>Case 2</td> <td>Any correct proof without complete reasons.</td> <td>1</td> </tr> <tr> <td>Case 3</td> <td>Any relevant correct argument with correct reason: (Lines 1 to 3)</td> <td>1</td> </tr> </tbody> </table>			Marking Scheme :			Case 1	Any correct proof with correct reasons.	2	Case 2	Any correct proof without complete reasons.	1	Case 3	Any relevant correct argument with correct reason: (Lines 1 to 3)	1
Marking Scheme :														
Case 1	Any correct proof with correct reasons.	2												
Case 2	Any correct proof without complete reasons.	1												
Case 3	Any relevant correct argument with correct reason: (Lines 1 to 3)	1												
<p>(b) (Line 1)... In $\triangle ABE$ and $\triangle CDF$</p> <p>(Line 2)... $\angle ABE = \angle CDF$ (proved)</p> <p>(Line 3)... $AB = CD$ (opp. sides of parallelogram)</p> <p>(Line 4)... $BE = DF$ (proved)</p> <p>(Line 5)... $\therefore \triangle ABE \cong \triangle CDF$ (SAS)</p> <p>(Line 6)... Hence $\angle AEB = \angle CFD$ (proved)</p> <p>(Line 7)... $EA \parallel CF$ (alt. \angles equal)</p>	<p>(2)</p>	<p>or (properties of parallelogram) [//四邊形對邊] [(內)錯角相等]</p>												
<table border="1"> <thead> <tr> <th colspan="3">Marking Scheme :</th> </tr> </thead> <tbody> <tr> <td>Case 1</td> <td>Any correct proof with correct reasons.</td> <td>4</td> </tr> <tr> <td>Case 2</td> <td>Any correct proof without reasons. In addition, any relevant correct argument with correct reason (at most 1 mark).</td> <td>2 1</td> </tr> <tr> <td>Case 3</td> <td>Any relevant correct argument with correct reason: (Lines 2 to 7)</td> <td>1</td> </tr> </tbody> </table>			Marking Scheme :			Case 1	Any correct proof with correct reasons.	4	Case 2	Any correct proof without reasons. In addition, any relevant correct argument with correct reason (at most 1 mark).	2 1	Case 3	Any relevant correct argument with correct reason: (Lines 2 to 7)	1
Marking Scheme :														
Case 1	Any correct proof with correct reasons.	4												
Case 2	Any correct proof without reasons. In addition, any relevant correct argument with correct reason (at most 1 mark).	2 1												
Case 3	Any relevant correct argument with correct reason: (Lines 2 to 7)	1												
	<p>(4)</p>													

Solution	Marks	Remarks															
<p>15. (a) Service reservoir will be empty when $D = 0$.</p> <p style="padding-left: 40px;">When $t = 11$, $D > 0$. (for ref. $D = 1.904$)</p> <p style="padding-left: 40px;">When $t = 12$, $D < 0$. (for ref. $D = -0.488$)</p> <p>Using the method of bisection,</p> <table border="1" style="margin-left: 40px;"> <thead> <tr> <th>Interval</th> <th>mid-value</th> <th>D</th> </tr> </thead> <tbody> <tr> <td>$11 < t < 12$</td> <td>11.5</td> <td>+ve (0.760)</td> </tr> <tr> <td>$11.5 < t < 12$</td> <td>11.75</td> <td>+ve (0.149)</td> </tr> <tr> <td>$11.75 < t < 12$</td> <td>11.88</td> <td>-ve (-0.179)</td> </tr> <tr> <td>$11.75 < t < 11.88$</td> <td>11.82</td> <td>-ve (-0.027)</td> </tr> </tbody> </table> <p style="margin-left: 40px;">$\therefore 11.75 < t < 11.82$</p> <p style="margin-left: 80px;">$t \approx 11.8$ (correct to the nearest 0.1)</p> <p>i.e. The reservoir will be empty in 11.8 days.</p>	Interval	mid-value	D	$11 < t < 12$	11.5	+ve (0.760)	$11.5 < t < 12$	11.75	+ve (0.149)	$11.75 < t < 12$	11.88	-ve (-0.179)	$11.75 < t < 11.88$	11.82	-ve (-0.027)	<p style="text-align: center;">1A</p> <p style="text-align: center;">1M 1M</p> <p style="text-align: center;">1A</p> <hr style="width: 20%; margin: 0 auto;"/> <p style="text-align: center;">(4)</p>	<p>accept '\leq' etc. accept implicitly shown in the table below</p> <p>accept any interval containing the root as the starting interval testing sign of mid-value choosing the correct interval</p> <p>f.t. ignore unit</p>
Interval	mid-value	D															
$11 < t < 12$	11.5	+ve (0.760)															
$11.5 < t < 12$	11.75	+ve (0.149)															
$11.75 < t < 12$	11.88	-ve (-0.179)															
$11.75 < t < 11.88$	11.82	-ve (-0.027)															
<p>(b) Let $V \text{ m}^3$ be the capacity of service reservoir Y, then the filling rates of pipe A, B and C are $\frac{V}{x+3} \text{ m}^3/\text{day}$, $\frac{V}{x} \text{ m}^3/\text{day}$ and $\frac{V}{x-2} \text{ m}^3/\text{day}$ respectively.</p> <p>$\therefore \frac{V}{x+3} + \frac{V}{x} + \frac{V}{x-2} = \frac{V}{4}$</p> <p>$\frac{1}{x+3} + \frac{1}{x} + \frac{1}{x-2} = \frac{1}{4}$</p> <p>$\frac{3x^2 + 2x - 6}{x^3 + x^2 - 6x} = \frac{1}{4}$</p> <p>$x^3 - 11x^2 - 14x + 24 = 0$</p> <p>$\therefore x^3 - 11x^2 - 14x + 24 = (x-1)(x+2)(x-12)$</p> <p>$x = -2, 1$ or 12</p> <p>By the nature of the problem, the first two roots are rejected. Hence $x = 12$</p>	<p style="text-align: center;">1M+1A</p> <p style="text-align: center;">1</p> <p style="text-align: center;">1A+1A</p> <p style="text-align: center;">1A</p> <hr style="width: 20%; margin: 0 auto;"/> <p style="text-align: center;">1A</p> <p style="text-align: center;">(7)</p>	<p>1M for any rate such as $\frac{1}{x+3}$ or $\frac{V}{x+3}$ etc.</p> <p>1A for any correct factor</p> <p>f.t.</p>															

Solution	Marks	Remarks
16. (a)(i) (Line 1)... $\angle ACF = \angle DEF$ (corr. \angle s, $AC \parallel DE$)		accept (corr. \angle s, //lines) [同位角, $AC \parallel DE$]
(Line 2)... $\angle DEF = \angle DBF$ (\angle s in same segment)		[同弓形內的圓周角] 或 [對同弧的圓周角]
(Line 3)... $\therefore \angle ACF = \angle DBF$		
(Line 4)... Hence A, F, B and C are concyclic. (conv. of \angle s in same segment)		or (AF /line subtends eq. \angle s), (\angle s in same segment eq.) [同弓形內圓周角的逆定理]

Marking Scheme :		
Case 1	Any correct proof with correct reasons.	3
Case 2	Any correct proof without reasons. In addition, any relevant correct argument with correct reason (at most 1 mark).	1 1
Case 3	Any relevant correct argument with correct reason: (Lines 1, 2 and 4)	1

- (ii) $\therefore A, F, B$ and C are concyclic and $\angle ABC = 90^\circ$
 $\therefore AC$ is a diameter of the circle $AFBC$
 Hence M is the centre and MB, MF are radii of the circle $AFBC$
 $\therefore MB = MF$

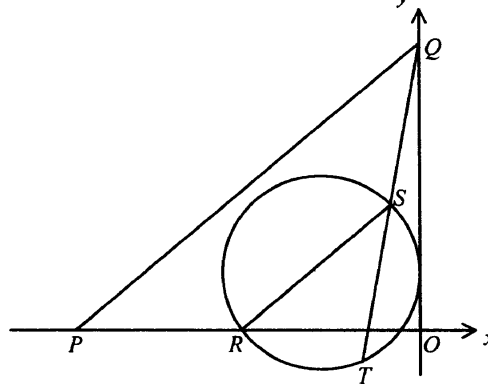
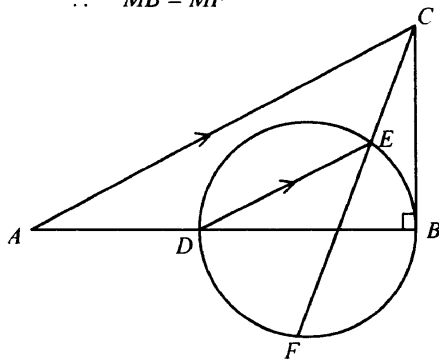

- (b) (i) \therefore slope of $PQ =$ slope of $RS = 1$
 $\therefore PQ \parallel RS$

(ii) Equation of QS : $\frac{y-17}{x} = \frac{17-7}{2}$
 $y = 5x + 17$

Sub. into the equation of the circle:

$$x^2 + (5x + 17)^2 + 10x - 6(5x + 17) + 9 = 0$$

$$13x^2 + 75x + 98 = 0$$

$$(x + 2)(13x + 49) = 0$$

The coordinates of T are $(-\frac{49}{13}, -\frac{24}{13})$. $(-3.77, -1.85)$

1

1A

1M

1A

Solution	Marks	Remarks
<p>(iii) Equation of the circle PQO is</p> $\left(x + \frac{17}{2}\right)^2 + \left(y - \frac{17}{2}\right)^2 = \frac{289}{2}$ $x^2 + y^2 + 17x - 17y = 0$ <p>$\therefore T$ does not satisfy the above equation</p> <p>$\therefore P, Q, O$ and T are not concyclic.</p>	<p>1A</p> <p>1</p>	
<p>$\therefore m_{PT} = \frac{\frac{24}{13}}{-17 + \frac{49}{13}} = -\frac{6}{43}$</p> <p>$m_{QT} = \frac{17 + \frac{24}{13}}{\frac{49}{13}} = 5$</p> <p>$m_{PT}m_{QT} \neq -1$</p> <p>$\therefore \angle POQ = 90^\circ \neq \angle PTQ$</p> <p>$P, Q, O$ and T are not concyclic.</p>	<p>1A</p> <p>1</p>	<p>for m_{PT} and m_{QT}</p>
<p>\therefore Circle POQ has radius $\frac{17\sqrt{2}}{2}$ and centre $\left(-\frac{17}{2}, \frac{17}{2}\right)$, say N,</p> <p>while $NT = \sqrt{\left(\frac{17}{2} - \frac{49}{13}\right)^2 + \left(\frac{17}{2} + \frac{24}{13}\right)^2} (\approx 11.376)$</p> <p>$\neq \frac{17\sqrt{2}}{2}$</p> <p>$\therefore P, Q, O$ and T are not concyclic.</p>	<p>1A</p> <p>1</p>	
<p>(6)</p>		

Solution	Marks	Remarks
<p>17. (a) $500000(1-r\%)^{11} = 284400$</p> $1-r\% = \sqrt[11]{\frac{284400}{500000}} \approx 0.95$ <p>$r \approx 5$</p>	<p>1M+1A</p> <hr/> <p>1A (3)</p>	<p>$500000R^n = 284400$</p>
<p>(b) (i) Income for the whole year</p> $= (\$) \frac{500000(1-0.95^{12})}{1-0.95}$ <p>$\approx (\\$) 4596399$</p> <p>Production cost for the whole year</p> $= (\$) \frac{12}{2} (2 \times 400000 - 20000 \times 11)$ <div style="border: 1px solid black; display: inline-block; padding: 2px;"> $400000 + 380000 + 360000 + 340000 + \dots + 180000$ </div> <p>$= (\\$) 3480000$</p> <p>$\therefore$ Income > Production cost</p> <p>\therefore The factory will still make a profit for the whole year.</p>	<p>1M</p> <p>1A</p> <p>1M</p> <p>1A</p>	<p>$\frac{500000(1-R^n)}{1-R}$</p> <p>r.t. 4600000</p> <p>$\frac{q}{2} (2 \times 400000 - 20000(q-1))$</p>
<p>(ii) Let the research be stopped at the end of the k-th month.</p> $300000k > 3480000 - \frac{k}{2} [2 \times 400000 - 20000(k-1)]$ $30k > 348 - 40k + k(k-1)$ $k^2 - 71k + 348 < 0$ $\frac{71 - \sqrt{71^2 - 4 \times 348}}{2} < k < \frac{71 + \sqrt{71^2 - 4 \times 348}}{2}$ <p>$5.2965 < k < 65.7035$</p> <p>\therefore The research project will last for 6 months.</p>	<p>1M</p> <p>1</p> <p>1A</p> <hr/> <p>1A (8)</p>	

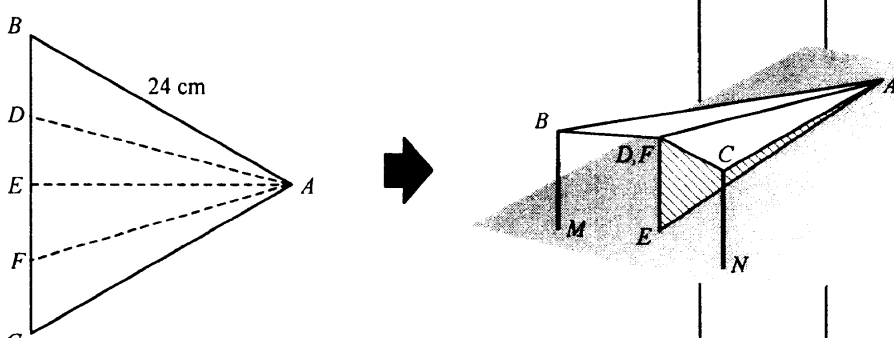
Solution	Marks	Remarks
<p>18.</p> 		
<p>(a) $AD^2 = AB^2 + BD^2 - 2(AB)(BD) \cos \angle ABD$ $= 24^2 + 6^2 - 2 \times 24 \times 6 \cos 60^\circ \text{ (cm}^2\text{)}$ $= 468 \text{ (cm}^2\text{)}$ $\therefore AD \approx 21.6 \text{ (cm)} \quad \text{(or } 6\sqrt{13}\text{)}$</p> <p>$\therefore \frac{\sin \angle BAD}{BD} = \frac{\sin \angle ABD}{AD}$ $\therefore \sin \angle BAD = \frac{6 \sin 60^\circ}{AD}$</p> <div style="border: 1px solid black; padding: 5px; display: inline-block;"> $\cos \angle BAD = \frac{24^2 + (AD)^2 - 6^2}{2(24)(AD)}$ </div> <p>$\approx \frac{6 \sin 60^\circ}{21.633} \quad \text{(or } \frac{6 \sin 60^\circ}{6\sqrt{13}}\text{)}$ $\approx 0.240 \quad \text{(or } \frac{\sqrt{39}}{26}\text{)}$ $\angle BAD \approx 13.9^\circ$</p>	<p>2A</p> <p>2M</p>	<p>(21.633)</p>
<p>$AE = \sqrt{AB^2 - BE^2}$ $= \sqrt{24^2 - 12^2}$ $= 12\sqrt{3} \quad \text{(or } \sqrt{432}\text{)}$</p> <p>$\angle DAE = \tan^{-1} \frac{6}{AE}$ $\approx 16.1^\circ$ $\angle BAD = 30^\circ - \angle DAE \approx 13.9^\circ$</p>	<p>2A</p> <p>2M</p>	
<p>Distance between the tips of the wings</p> <p>$= 2(24 \sin \angle BAD) \text{ (cm)}$</p> <div style="border: 1px solid black; padding: 5px; display: inline-block;"> $\sqrt{24^2 + 24^2 - 2(24)^2 \cos 27.8^\circ}$ </div> <div style="border: 1px solid black; padding: 5px; display: inline-block;"> $\sqrt{6^2 + 6^2 - 2(6)^2 \cos 147.8^\circ}$ </div> <p>$\approx 2 \times 24 \times 0.2402 \text{ (cm)} \quad \text{(or } 2 \times 24 \times \frac{\sqrt{39}}{26}\text{)}$ $\approx 11.5 \text{ cm} \quad \text{(or } \frac{24\sqrt{39}}{13}\text{)}$</p>	<p>1M</p> <p>1A</p> <p>(6)</p>	<p>r.t. 11.5 (11.529)</p>

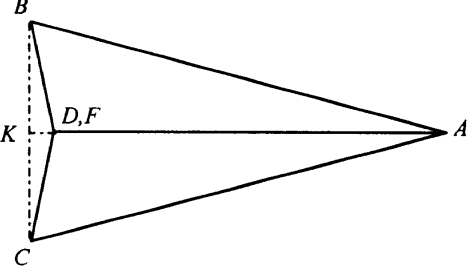
Solution	Marks	Remarks
<p>(b) Inclination of the wings to the horizontal ground $= \angle DAE$ (or $\angle FAE$) $= \sin^{-1} \frac{6}{AD}$ $30^\circ - 13.9^\circ$ $\approx 16.1^\circ$ (or $16^\circ 6'$)</p>  <p style="text-align: right;">(Top view)</p>	<p>1M <hr style="width: 50%; margin: 0;"/>1A (2)</p>	<p>r.t. 16.1 (16.102)</p>
<p>(c) Let K be the mid-point of the wings' tips. $AK = 24 \cos \angle BAD$ $= 24 \cos 13.9^\circ$ (or $24\sqrt{1 - 0.2402^2}$) ≈ 23.3 (or $\frac{84\sqrt{13}}{13}$)</p> <p>$CN =$ height of point K from the ground $= AK \sin \angle DAE$ $\approx 23.297 \times \frac{6}{21.633}$ (cm) ≈ 6.46 cm (or $\frac{84}{13}$)</p>	<p>1M 1M <hr style="width: 50%; margin: 0;"/>1A (3)</p>	<p>(23.297) r.t. 6.46 (6.4615)</p>